

Modular Combi Plastic

The enclosure is in plastic. Modul Combi Plastic is designed for different types of single phase domestic outlets and for IEC outlets up to and including 63 A.

Operating voltage 230/400 V ~

Enclosure: Plastic (PBT Thermoplastic)

Dimensions: According to table

Outlets: Combi Plastic is designed for different types of single phase domestic outlets and for IEC outlets up to and including 63 A.

With or without mechanical interlocked IEC outlets.

Cable entry: 4 knock-outs at the top, suitable for 2xØ 40 mm and 2xØ 25 mm

At the bottom 3xØ 47 mm

Cable area: 2x16 mm² Cu. Designed for looping

Covers: For MCB/RCD, maximum 13 modules, 2 opened and knock-outs for the rest of the modules row. DIN-rail in bottom for terminals and MCB/RCDs.

With a distance at the bottom to allow wiring behind the rail. The lid is pad lockable.



Modular Combi

Plastic 16 A

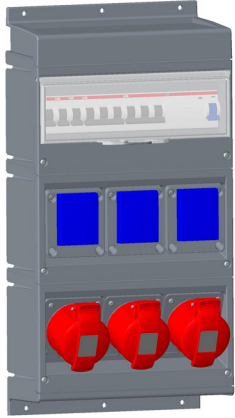

MPR16/3

IP44, Splashproof

MCB	RCD	Switch	Schuko outlet		Type	Order Code	Size			Weight pkg (1pce) kg
			10/16 A	IEC			W	H	D	
1xS203 M C16	25 A/0.03	-	2 single	1x416	MPR16	2CMA168997R1000	250	300	160	3.1
3xS201 C16 2xS203 M C16	40 A/0.03	-	3 single	3x416	MPR16/3	2CMA168995R1000	250	430	160	3.4
1xS203 M C16	25 A/0.03	-	2 single	1x416	MPR16B *	2CMA101631R1000	250	300	160	3.1
1xS203 M C16	25 A/0.03	-	2 single	1x416	MPR16 BS Grey **	2CMA101651R1000	250	300	160	3.1
1xS203 M C16	25 A/0.03	-	2 single	1x416	MPR16 BS Black **	2CMA101655R1000	250	300	160	3.1

* Black enclosure

** Domesti outlet with British standard

Modular Combi

Plastic 16 A

Front view

Wiring diagram

MPR16

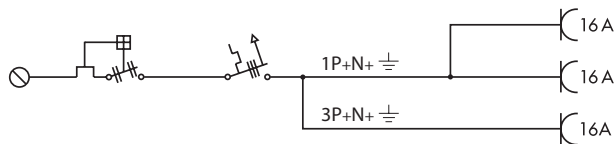
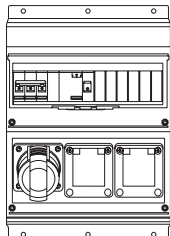

MPR16B

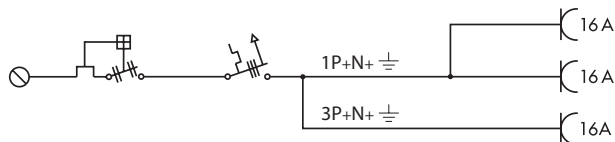
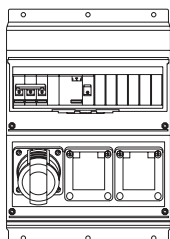

MPR16 BS Grey

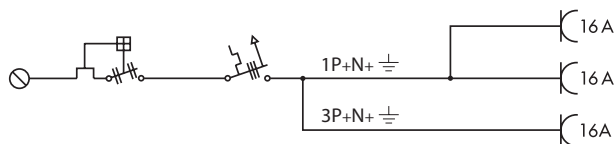
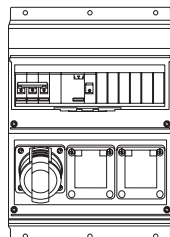

MPR16B BS Black

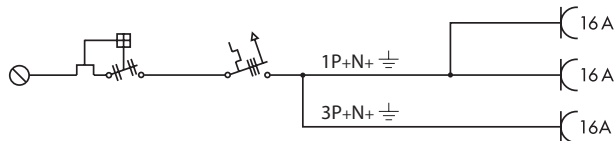
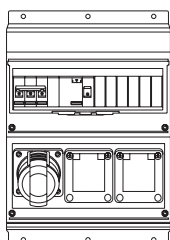

MPR16/3

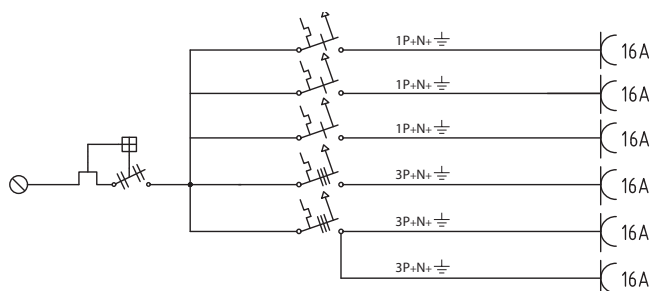
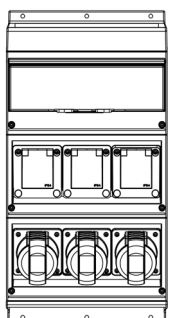

Modular Combi

Plastic 32 A

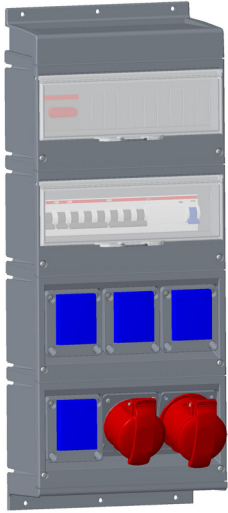

IP44, Splashproof

MCB	RCD	Switch	Schuko outlet 10/16 A	Outlet IEC	Type	Order Code	Size			Weight pkg (1pce) kg
							W	H	D	
3xS201 C16 1xMCB S203-C16 1xMCB S203-C32	63 A/0.03	-	3 single	1x416 1x432	MPR32/1	2CMA106211R1000	250	430	160	4.3
2xMCB S201-C16 1xMCB S203-C16 1xMCB S203-C32	63 A/0.03	OT80F3/B	4 single	1x416 1x432	MPR32/1MS	2CMA168984R1000	250	560	160	4.8

MPR32/1MS

Front view

Wiring diagram

MPR32/1

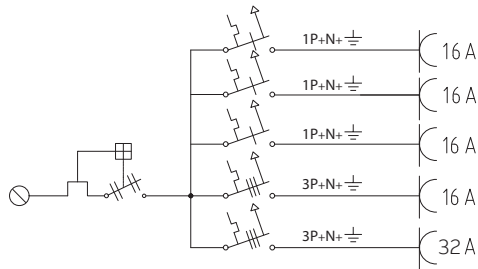
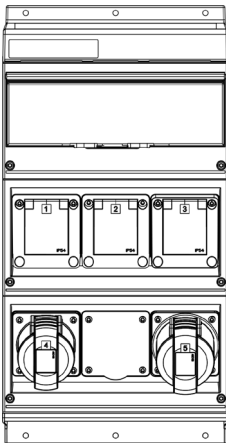

MPR32/1MS

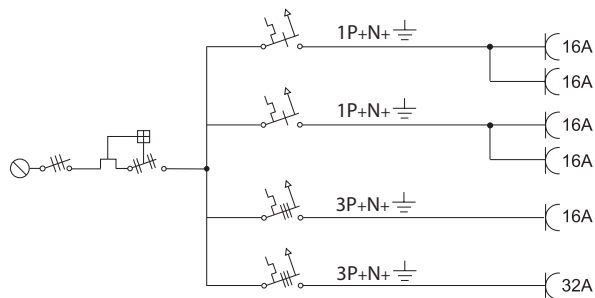
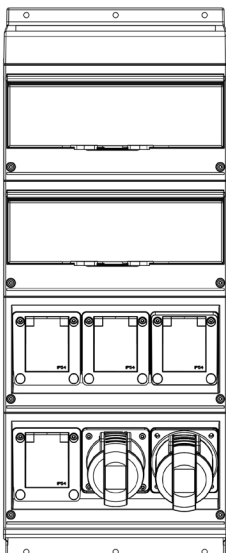

Modular Combi

Plastic

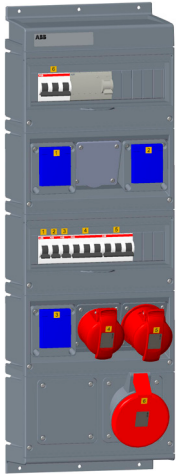

MPR63PRO

IP44, Splashproof
Housing in plastic (PBT)

MCB	RCD	Switch	Schuko outlet	Outlet	Type	Order Code	Size			Weight pkg (1pce)
			10/16 A	IEC			W	H	D	
3xS201-C16 1xS203-C16 1xS203-C32 1xS203-C63	40 A/0.03		3 single	1x416 1x432 1x463	MPR63PRO	2CMA101808R1000	250	750	165	4.0
3xS201-C16 1xS203-C16 1xS203-C32 1xS203-C63	63 A/0.03		3 single	1x416 1x432 1x463	MPR63/ 1PRO	2CMA101809R1000	250	750	165	5.4
3xS201-C16 1xS203-C16 1xS203-C32 1xS203-C63	63 A/0.03	OT80F3	3 single	1x416 1x432 1x463	MPR63/ 1MSPRO	2CMA101810R1000	250	750	165	5.7

Front view

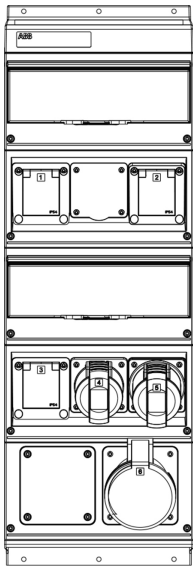

MPR63PRO

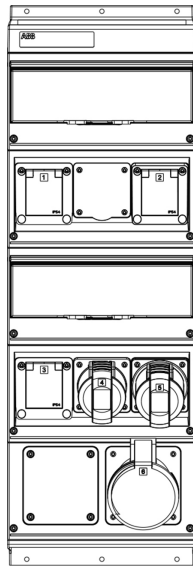

MPR63/1PRO

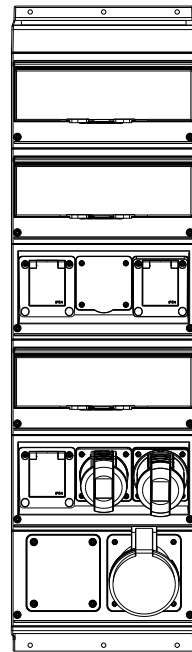

MPR63/1MSPRO

Wiring diagrams

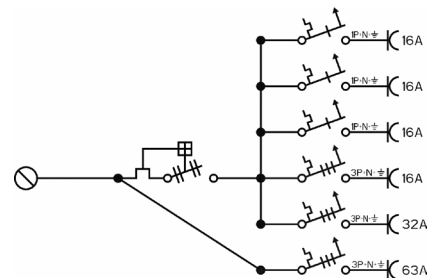

MPR63PRO

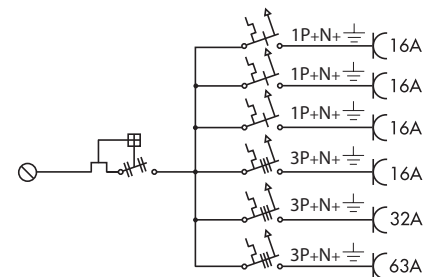

MPR63/1PRO

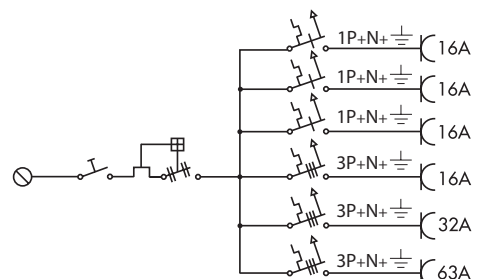

MPR63/1MSPRO

Modular Combi Metal

The enclosure is in aluminium with front plates of galvanised steel. Modul Combi Metal is designed for different types of single phase domestic outlets and for IEC outlets up to and including 63 A.

Operating voltage 230/400 V~

Enclosure: Aluminium with front plates of galvanised steel.

Dimensions: According to table or customer order

Outlets: Combi Metal is designed for different types of single phase domestic outlets and for IEC outlets up to and including 63 A.
With or without mechanical interlocked IEC outlets.

Cable entry: FL21 flange openings at top and bottom

Cable area: 2x16 mm² Cu. Designed for looping

Covers: For MCB/RCD, maximum 12 modules. DIN-rail in bottom for terminals and MCB/RCDs.
With a distance at the bottom to allow wiring behind the rail. The lid is pad lockable.

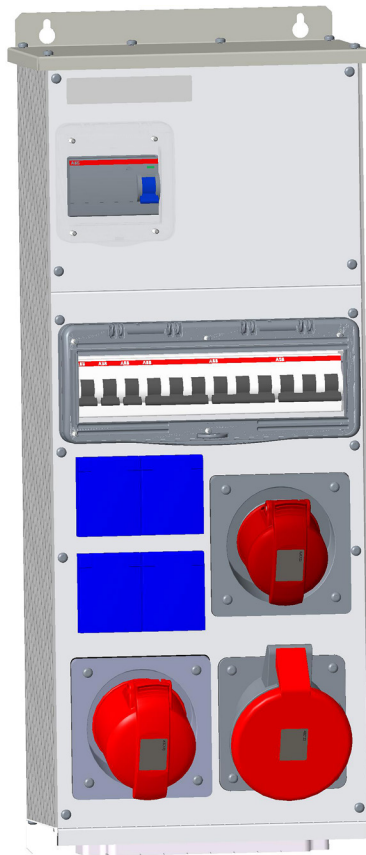

Modular Combi

Metal

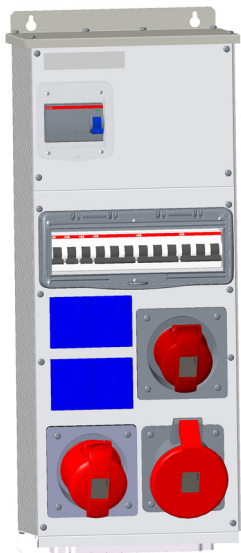

M63/2 JFB CTFL

IP44, Splashproof

Housing in Aluminium with front plates of galvanised steel

Cable entry Alt 1: FL21 flange openings at top and bottom

Cable entry Alt 2: Covered top and rubber multi gland down (CTFL)

MCB	RCD	Switch	Schuko Outlet		Type	Order Code	Size			Weight pkg (1pce) kg
			10/16 A	IEC			W	H	D	
2xS201-C10 1xS203-C16	25 A/0.03		2 single	1x416	M16/2 JFB	2CMA179349R1000	250	314	172	4.55
2xS201-C10 1xS203-C16	25 A/0.03		2 single	1x416	M16/2 JFB CTFL	2CMA100020R1000	250	314	172	4.55
4xS201-C10 1xS203-C16 1xS203-C32	63 A/0.03		4 single	1x416 1x432	M32/2 JFB	2CMA179351R1000	250	574	179	7.35
4xS201-C10 1xS203-C16 1xS203-C32	63 A/0.03		4 single	1x416 1x432	M32/2 JFB CTFL	2CMA100022R1000	250	574	179	7.35
3xS201-C10 1xS203-C16 1xS203-C32 1xS203-C63	63 A/0.03		4 single	1x416 1x432 1x463	M63/2 JFB CTFL	2CMA100024R1000	250	704	188	9.55
3xS201-C10 1xS203-C16 1xS203-C32 1xS203-C63	63 A/0.03		4 single	1x416 1x432 1x463	M63/2 JFB	2CMA179353R1000	250	704	188	9.55

CTFL = Covered top and FL21 with multiflange down

Modular Combi

Metal

Front view

Wiring diagram

M16/2JFB
M16/2 JFB CTF

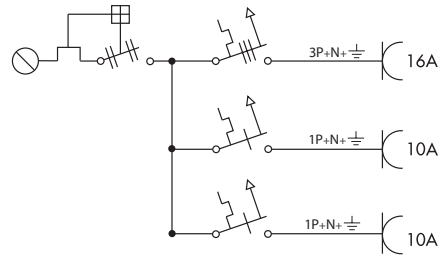
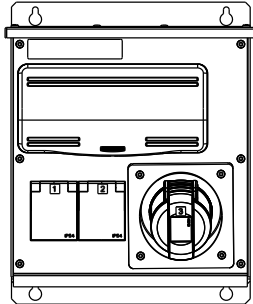

M32/2JFB
M32/2 JFB CTF

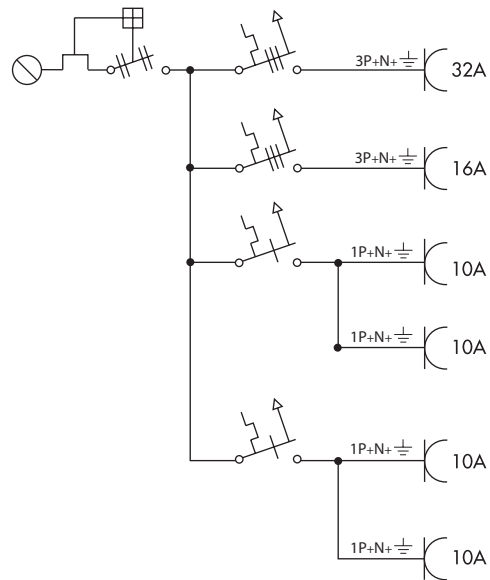
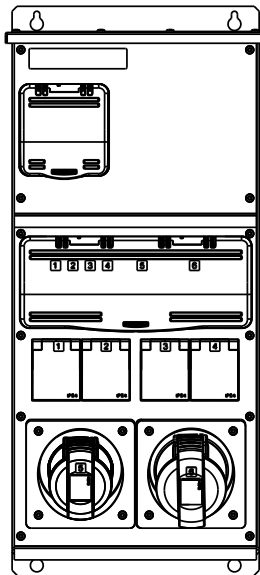

M63/2JFB
M63/2 JFB CTF

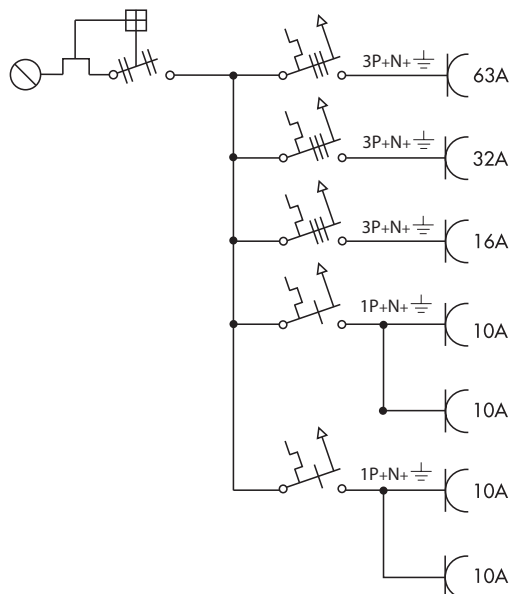
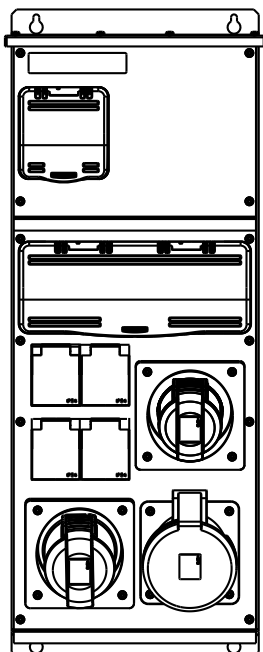

Modular Combi Parts

Here you can design your installation solution in IP44

Modular combi parts are Easy to assemble and install. It is a flexible and time efficient choice for special applications. Modular combi parts can be assembled to a height of 2 meters and there is a possibility to build on the width by looping if required. Din rail are suitable for 13 modules with a lot of space for your socket outlets protection. There are a large number of socket outlets to

choose from our Easy & Safe and Tough & Safe Range depending on which IP degree and material that is required. There is also a possibility to have switched interlocked socket outlet to maximize personal safety. Assembled enclosure is tested and fulfills IP44 protection degree and can handle Socket outlets up to 63A. Enclosure parts in plastic PBT.

IP44 sockets
16-32A page 24-25
63A page 133

IP67 sockets
16-32A page 134-135

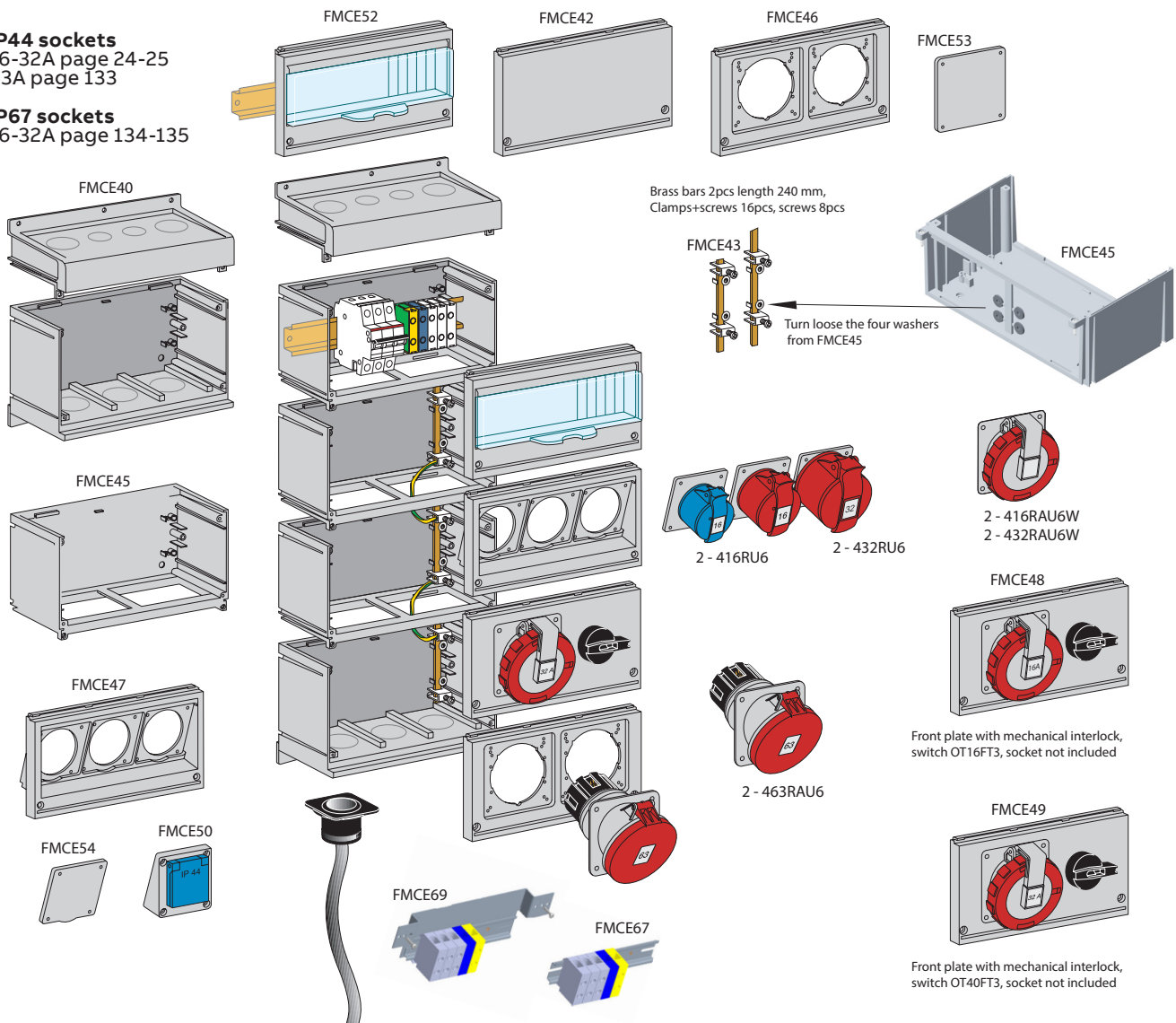

Modular Combi parts

Top, bottom and middle section. Front and cover plates, cable flange and N/E terminal

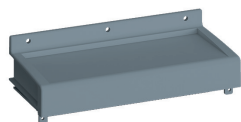

Top section FMCE40

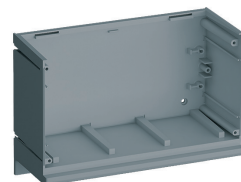

Bottom section FMCE40

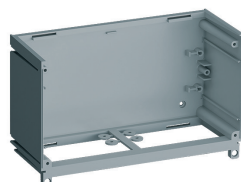

FMCE45

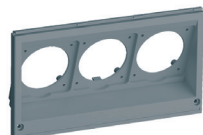

FMCE47

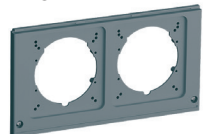

FMCE46

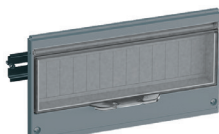

FMCE52

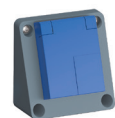

FMCE50



FMCE41



FMCE54



FMCE53



FMCE42



FMCE43

Parts in plastic (PBT)

Description	Type	Order Code	Pkg qty	Weight pkg (1pce) kg
Top and bottom section				
Top (2x40 mm and 2x25 mm) and bottom (3x47 mm) section incl. screws. Suitable for MP..., MPR...	FMCE40	2CMA191077R1000	1 pce	0.2kg
Middle section				
Middle section incl. screws. Suitable for MP..., MPR...	FMCE45	2CMA191082R1000	1 pce	0.25kg
Front plate for 16-32 A outlet				
Front plate suitable for three 16-32 A outlets incl. screws. Suitable for RU and FMCE50	FMCE47	2CMA191084R1000	1 pce	0.5kg
Front plate for 63 A outlet				
Front plate suitable for two 63 A outlets incl. screws	FMCE46	2CMA191083R1000	1 pce	0.5kg
Front plate with mechanical interlock				
Front plate with mechanical interlock, switch OT16FT3, socket not included	FMCE48	2CMA191085R1000	1 pce	0.5kg
Front plate with mechanical interlock				
Front plate with mechanical interlock, switch OT40FT3, socket not included	FMCE49	2CMA191086R1000	1 pce	0.5kg
Front plate with lid and DIN rail				
Front with lid and DIN rail L=241 mm	FMCE52	2CMA191089R1000	1 pce	0.1kg
Front plate with schuko				
Front plate with schuko outlet 10/16 A, incl. screws. Suitable for FMCE47	FMCE50	2CMA191087R1000	1 pce	0.2kg
Cover plate for 16-32 A				
Cover plate suitable for 16-32 A incl. screws	FMCE54	2CMA191091R1000	1 pce	0.1kg
Cover plate for 63 A				
Cover plate suitable for 63 A incl. screws	FMCE53	2CMA191090R1000	1 pce	0.1kg
Cover plate				
Cover plate incl. screws	FMCE42	2CMA191079R1000	1 pce	0.5kg
Cable flange				
Hose clamp, cable tightening, flange incl. screws	FMCE41	2CMA170188R1000	1 pce	0.25kg
N/E terminal				
N/E terminal 16 mm ² , brass bar = 240 mm	FMCE43	2CMA191080R1000	1 pce	0.19kg
DIN-Rail				
DIN-Rail L=241 mm + screws + 5x35 mm ² terminal block	FMCE67	2CMA191103R1000	1 pce	0.3kg
Flange				
Flange for domestic socket, incl. screws	FMCE70	2CMA105989R1000	1 pce	0.2kg
DIN-Rail				
DIN-Rail L=241 mm, incl. screws	FMCE71	2CMA105990R1000	1 pce	0.1kg
DIN-Rail				
Lowered DIN-Rail, incl. screws	FMCE72	2CMA105991R1000	1 pce	0.3kg

Multi-pack Modular Combi

Top, bottom and middle section. Front and cover plates, cable flange and N/E terminal

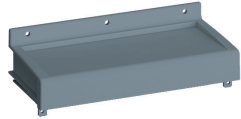

Top section FMCE400

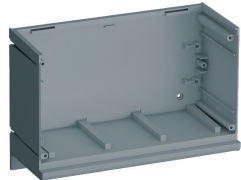

Bottom section FMCE400

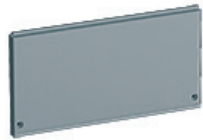

FMCE420



FMCE430

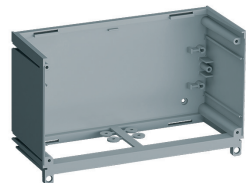

FMCE450

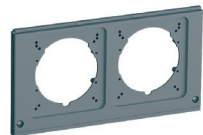

FMCE460

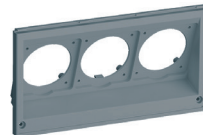

FMCE470

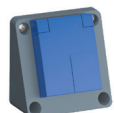

FMCE500



FMCE54

FMCE53

Parts in plastic (PBT)

Description	Type	Order Code	Pkg qty
Top section knock outs			
Bottom section knock outs			
(2x Ø 40,5 mm and 2x Ø 25,5 mm) (2x Ø 40,5 mm and 1x Ø 47,5 mm) screws incl. and instruction	FMCE400	2CMA106004R1000	5
Hose clamp			
cable tightening, flange, C-nuts, screws incl.	FMCE410	2CMA106005R1000	10
Cover plate			
screws incl.	FMCE420	2CMA106006R1000	10
N/E terminals 16 mm²			
Brass bars 2pcs length 240 mm, Clamps 16pcs, screws 8pcs	FMCE430	2CMA106007R1000	10
Middle section			
screws incl.	FMCE450	2CMA106008R1000	10
Front plate			
suitable for two 63 A outlets screws incl.	FMCE460	2CMA106009R1000	10
Front plate			
suitable for three 16-32 A outlets screws incl.	FMCE470	2CMA106010R1000	10
Flange			
with Schuko outlet 10/16 A, screws incl.	FMCE500	2CMA106011R1000	10
Front			
with lid (13 DIN modules wide), DIN-rail, screws incl.	FMCE520	2CMA106012R1000	10
Cover flange 63			
screws incl.	FMCE530	2CMA106013R1000	10
Cover flange 16/32			
screws incl.	FMCE540	2CMA106014R1000	10
Flanges for Domestic socket			
screws incl.	FMCE700	2CMA106016R1000	10
DIN Rail 241 mm			
screws incl.	FMCE710	2CMA106017R1000	10
Lowered DIN-rail			
screws incl.	FMCE720	2CMA106015R1000	10
Screw STS T40*16 FZB Screw TS KN1039 Screw RTK 3,5X13 Screw STS T40x20, PT 30* DELG L=20 MM	FMCE730	2CMA106018R1000	4x100 pcs

Black Modular Combi

Top, bottom and middle section. Front and cover plates, cable flange and N/E terminal



Top section FMCE40B



Bottom section FMCE40B



FMCE42B



FMCE45B



FMCE47B



FMCE54B

Parts in plastic (PBT)

Description	Type	Order Code	Pkg qty
Top section knock outs			
Bottom section knock outs			
(2x Ø 40,5 mm and 2x Ø 25,5 mm) (2x Ø 40,5 mm and 1x Ø 47,5 mm) screws incl. and instruction	FMCE40B	2CMA105995R1000	Qty 1
Cover plate			
screws incl.	FMCE42B	2CMA105996R1000	Qty 1
Middle section			
screws incl.	FMCE45B	2CMA105997R1000	Qty 1
Front plate			
suitable for three 16-32 A outlets screws incl.	FMCE47B	2CMA105998R1000	Qty 1
Flange with Schuko outlet 10/16 A			
screws incl.	FMCE50B	2CMA105999R1000	Qty 1
Front with lid (13 DIN modules wide)			
DIN-rail, screws incl.	FMCE52B	2CMA106001R1000	Qty 1
Cover flange 16/32			
screws incl.	FMCE54B	2CMA106002R1000	Qty 1
Flanges for Domestic socket			
screws incl.	FMCE70B	2CMA106000R1000	Qty 1